



**PROFICLOUD**  
Professional Cloud Solutions

**PC WORX Engineer**  
Programming Software

**PLCnext Technology**   
Designed by PHOENIX CONTACT

# The new era of automation

Open for the future, with a system to success

# Open for the future, with a system to success

Automation is currently experiencing an unprecedented global paradigm shift. Classic system structures are developing into globally interlinked production systems. Technologies are in flux. The demand for smart maintenance, digitization and flexible production processes is growing. Young engineers and software developers are shaping new working methodologies and future-oriented industrial business models are becoming possible thanks to cloud computing. Phoenix Contact offers a new, open automation solution and safeguards your success in the future. Enter the new era of automation.

## Find out more with the web code

For detailed information, use the web codes provided in this brochure. Simply enter # and the four-digit number in the search field on our website.

 **Web code:** #1234 (example)

Or use the direct link:  
[phoenixcontact.net/webcode/#1234](https://phoenixcontact.net/webcode/#1234)

## The world is changing – and automation is changing along with it

We are currently experiencing the development of megacities, rapidly advancing globalization and, as a result, the deterioration of energy and resources available. The pace of innovation is increasing rapidly, technologies are converging, and products and infrastructures are becoming more intelligent. Modern consumers determine the market, and individuality is becoming high in priority. Lot size one production is now already replacing serial production in many industries.

Production processes need to become more flexible and automation solutions need to become more communicative and adaptable to remain competitive on the market in the long term. Being digital is the new standard. Customers expect simplified user guidance, optimized user interfaces and simple interface management.

Industrie 4.0 is making classical communication relationships in automation systems obsolete. Cloud solutions are opening up new possibilities. In addition to the classic PLC program code in accordance with IEC 61131-3, there is an increasing need for also integrating modules from other programming languages. High-level languages in particular are gaining in importance.

We as Phoenix Contact aim to be a reliable partner for our customers. Therefore, as a manufacturer of modern automation systems, we develop control and software solutions that allow our customers to react flexibly to dynamically changing circumstances. We are committed to thinking ahead so that our customers' investments and their ability to compete on the market are secured in the long term.

This is why we have developed PLCnext Technology. With this technology, we have created the basis for an open control platform with a modular software solution that is ready to face all the challenges of the IoT world.

PLCnext Technology is the basis for technologically leading automation: It is not the strongest who persevere, but those who are able to adapt the best.

Hans-Jürgen Koch  
Head of Business Unit Control Systems

## Contents

---

The new era of automation – Our solutions at a glance	4
PC Worx Engineer – Modular software platform	6
PLCnext Technology – Future-proof control platform	12
PROFICLOUD – Professional cloud solutions	20

---



# The new era of automation

The combination of open control platform, modular engineering software and systemic cloud integration makes your company fit for the future of automation. With this solution, Phoenix Contact offers a comprehensive and coordinated automation system suitable for practically all industrial fields of application. Maximum openness and flexibility, simple adaptation to changing requirements, efficient use of existing and future software services and future and investment security are just some of the advantages of this solution. PLCnext Technology, PC Worx Engineer and Proficloud - three guarantees for your business success in the IoT world.

**PROFICLOUD**  
Professional Cloud Solutions

**PLCne**  
Designed by

## Your advantages

- ✓ Future security, thanks to an open, adaptable complete system in which new functions and technologies can be easily integrated
- ✓ Higher investment protection, because both the control platform and the cloud architecture are based on open-source components which are undergoing continuous manufacturer-neutral development
- ✓ Convenience for the user, thanks to the freedom of choice of his development environment
- ✓ Tailor-made complete solution, because software development kits make the individual extension of control and cloud applications possible

# PC Worx Engineer – Open to individuality, succeed more rapidly

Automation solutions need to be put into operation faster to shorten development times and to adjust production processes more quickly. Software is the key to success here. The new PC Worx Engineer modular software platform unifies all automation engineering tasks in one complete system. The basic version of the software is free. Thanks to further add-in functions, you can create an individually tailored solution to suit your application.

 Web code: #1509

## Your advantages

- ✓ Time and cost savings, thanks to faster and integrated programming in a single interface
- ✓ Less work and training required, thanks to an optimized user interface
- ✓ Investment protection, thanks to the use of future-oriented technologies and open interfaces
- ✓ Flexible engineering, through the integration of individual add-in functions
- ✓ Simplification of the engineering process, thanks to reusability and object-oriented programming

# PC WORX Engineer

Programming Software

## PC Worx Engineer – Modular software platform



### Open to individuality, succeed more rapidly

With the new PC Worx Engineer, a flexible engineering platform is available for programming in accordance with IEC 61131-3. Alongside the programming, the platform also unifies all other engineering tasks in one tool and thus enables the user-friendly configuration, visualization and diagnostics of the complete system.

The software is impressive thanks to its attractive design and optimized user interface.

You save time and costs in the development of your automation structure and avoid errors thanks to the reusability of user-specific automation modules. In this way, PC Worx Engineer enables the accelerated creation of future-proof automation solutions.

First of all, the secure programming was fully integrated in the software. The user therefore does not have to struggle with different editors and software products. This saves him time in coming up to speed with the system and thanks to the simplicity of operation, the user has a positive user experience in every interaction.

This is completed by the integration of security aspects at all points of the software; even here the user does not have to leave the familiar engineering environment. The holistic integration of security and safety concepts makes PC Worx Engineer a reliable and efficient programming tool.

Improved user guidance, well-defined and clear interfaces and individually adjustable functions round off the software.

The basic version of the new engineering platform is free. You can extend your software solution via add-in functions suited to your application and only pay for the functions that you need. In this way you can quickly and easily create your completely individual version of PC Worx Engineer.

## PC WORX Engineer

Programming Software

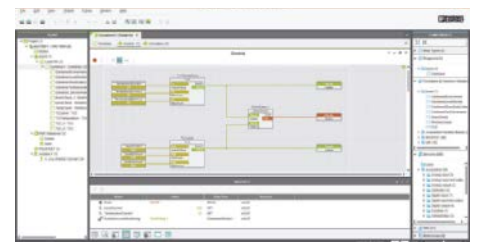

PC Worx Engineer is the innovative software solution with an optimized user interface



## A single software solution for all tasks – configuration, programming, diagnostics and visualization

In addition to standard and safe programming, PC Worx Engineer also combines visualization, configuration and diagnostics with numerous debug options into one tool. The deep integration of security concepts as well as all of these different automation tasks in one program give you a host of advantages: error avoidance, cost savings as well as time savings when creating the user application. This also makes it possible to significantly shorten development cycles and the training required.

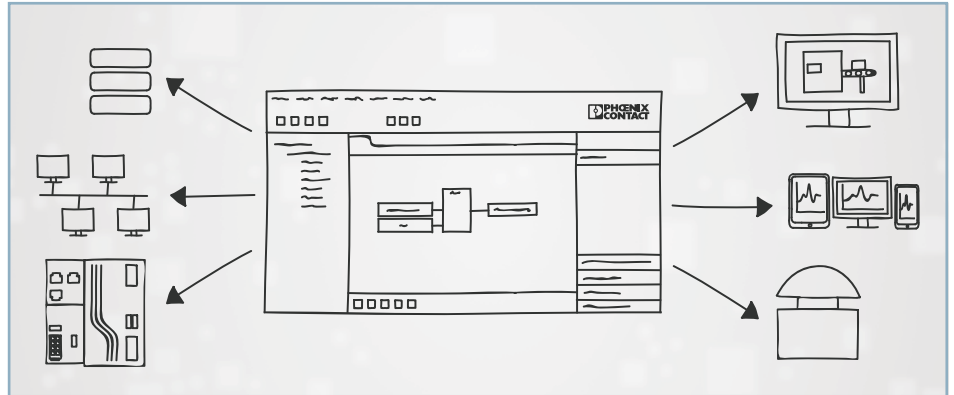

An engineering platform for all automation tasks

## Perfectly tailored to the user – configure software individually

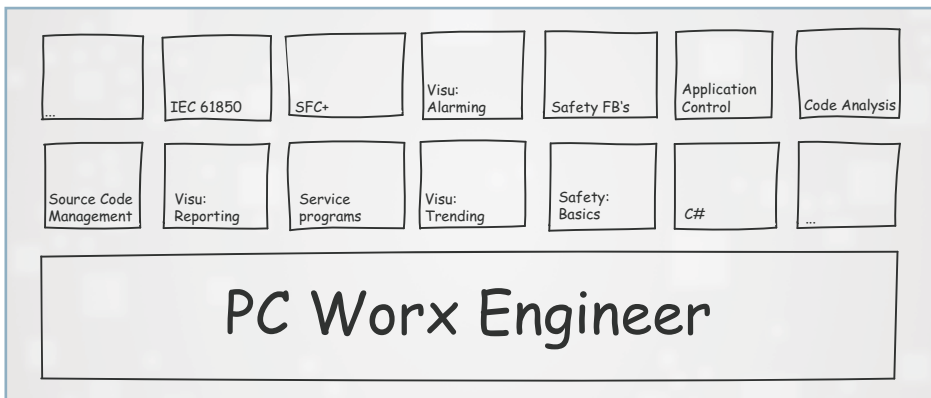

Extend the free software with add-in functions just as required

PC Worx Engineer is the free engineering platform that includes all basic functions for programming, visualization, diagnostics and hardware configuration.

Additional add-in functions, such as safety and visualization solutions, can be easily integrated into the platform. Use these add-ins to quickly and easily create your individual version of PC Worx Engineer. The modular software design supports intuitive user guidance thanks to its simple, structured interface:

You only see and pay for the functions that you really need.

## Investment protection guaranteed – software for future-oriented technologies

Future security and investment protection play an important role for engineering software as well. Customers who choose PC Worx Engineer should still be able to integrate future trends and new functions. This is why our software platform supports future-oriented technology:

- Open interfaces for integration into your engineering workflow
- Source code management for convenient working on shared applications for many users
- Integrated safety and security concept

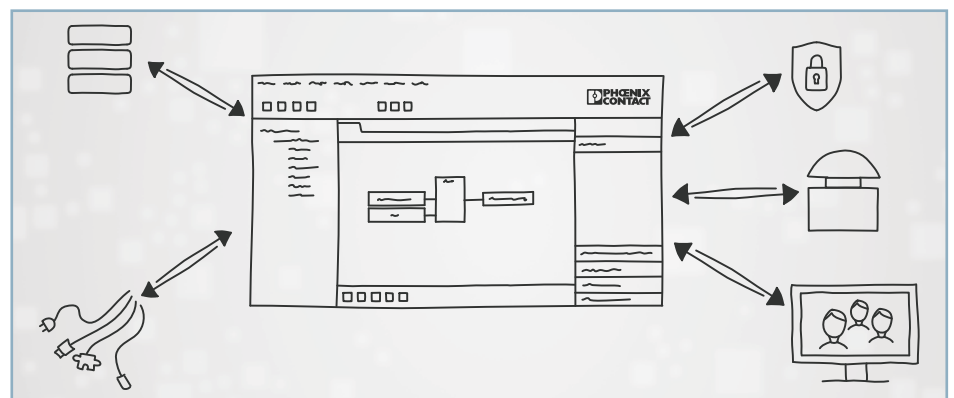

Open for extensions and new technological requirements of the future

## Improve quality and efficiency – reuse automation modules easily

The new PC Worx Engineer platform makes it possible to add automation modules that consist of defined software parts. This results in a host of advantages for software programmers. Development times can be shortened significantly thanks to the fast and simple reuse of these modules. This saves engineering costs and reduces error sources because it is only necessary to perform certifications, testing and programming once. The use of automation modules significantly increases the quality and efficiency of programming in complex systems in particular. Thanks to PLCnext Technology, program code can be processed in both IEC 61131-3 and in C/C++ or C#. Automation modules can thus themselves contain mixed program code.

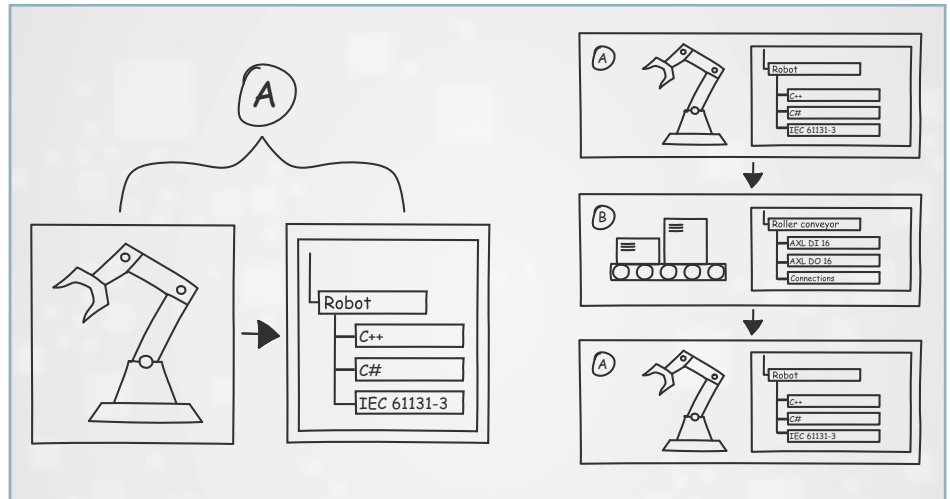

Accelerated development process, thanks to reusability of automation modules

## Create visualizations and programming in a single tool – PC Worx Engineer

The visualization software acts as the link between hardware and the user in automation solutions. Increased competitive pressure requires differentiating features – an optimized user interface is the calling card of the system and therefore represents an important distinguishing criterion.

PC Worx Engineer is not only programming software but also an ideal tool for creating modern visualizations. This integrated

platform concept has many advantages: operating concepts already known from programming simplify getting started and additional external software tools become obsolete. Programming and visualization work together reliably since they dovetail perfectly.

PC Worx Engineer makes it possible for you to create web-based visualizations based on open standards such as HTML5 and JavaScript:

- Scalable and adaptable – any device with a web browser can be used as an HMI client without any additional software.
- Resource-efficient – the performance of the controller is available for core tasks.
- Shortened development time – reusability of visualization templates, pre-configured objects as well as specially created icons.



Operate and monitor your processes on any Internet-capable device

## Finish applications faster, thanks to intuitive operating concepts

Modern automation software offers an increasing amount of functions and has to solve tasks that are becoming increasingly more complex. At the same time, users expect increasingly simple and intuitive operation, mainly due to the usage experiences gained in the consumer products area. Complicated structures and interfaces with a lack of structure result in decreased productivity and slow the engineering process down.

Our aim is to offer a modern software program that solves all the tasks of a highly complex industrial automation system, while at the same time enabling significantly faster engineering up to the finished application. The new platform was therefore developed in close cooperation with usability experts. Using context-sensitive menus and clear, well-structured interfaces avoids typical software operation issues that result in reduced productivity and slow down the engineering process. The PC Worx Engineer user interface only shows users the functions and actions they need for their current tasks.

The engineering interface is designed with the same structured principle in all work areas of the platform – no matter whether you are programming, visualizing or configuring:

- The editing area is the main worksheet at the center in the middle area.
- The worksheet is framed on the right by a list of all objects that are generally available.
- The collection of all previously used objects – the instances – are located on the left.
- Overall functions, such as a notification window or a cross-reference list, are initially located at the bottom of the software interface. You can show or hide these windows as desired to keep a better overview. When docked, the windows can always be found quickly and efficiently in their fixed position below the editing window.

Toolbars can be shown and hidden to make working with the new software platform even more efficient. This way, when a user creates a visualization, only the areas required are displayed and the interface does not show any functions that are only used for programming or configuration. These intelligent filter functions make it possible to specifically adjust numerous views, to reduce them and to adjust them individually to the respective needs of the user.

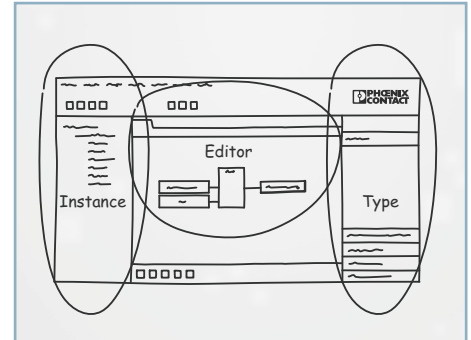

Intuitive operation and central editing, thanks to the clearly structured interface

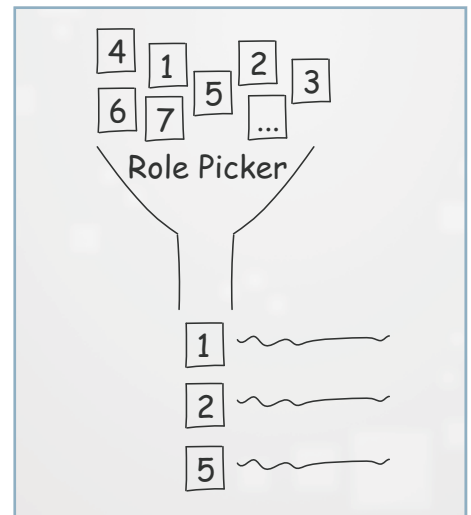

Simple selection of objects, thanks to the role picker function

## Assistance functions accelerate programming

### Role picker function for simple object selection

PC Worx Engineer supports the familiar Windows drag-and-drop function throughout the entire system.

The new role picker functionality significantly simplifies programming. This intelligent functionality only offers and displays objects to the programmer that can actually be used for the respective task.

It is no longer necessary to look for suitable modules in a catalog or for variables in a table because the role picker makes this task much easier.

### Inplace actions for fast editing

The editors in the PC Worx Engineer provide the user with so-called inplace actions. These buttons always appear in a context-sensitive manner when a defined action is possible on an object, and are placed graphically directly next to the object.

Searching for actions in toolbars becomes entirely obsolete and editing code and graphics becomes much more efficient.

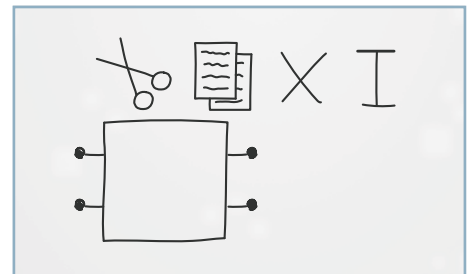

Rapid processing, thanks to context-sensitive menu navigation

# PLCnext Technology – Open to variety, succeed through flexibility

PLCnext Technology forms the basis of the new, open control platform from Phoenix Contact. This solution offers a unique combination of all communication characteristics and advantages of the classic PLC world with the openness and flexibility of smart devices. PLCnext Technology allows developers from various corporate areas, technology disciplines and generations to work in parallel with and yet independently of each other on one automation application – in the programming environment they are accustomed to.

 Web code: [#1509](#)



## Your advantages

- ✓ Accelerated startup because several developers can work on one program in parallel with and yet independently of each other in different programming languages
- ✓ Convenient engineering, thanks to the use of proven programming tools such as, for example, PC Worx, Matlab Simulink, Eclipse or Visual Studio
- ✓ More reliable operation, because determinism, real-time behavior and cycle-consistent data exchange are guaranteed regardless of the program language
- ✓ Cost-efficient and flexible, thanks to the use of freely available software from the open source community
- ✓ Future-proof and adaptable, because new functions and future technologies can be integrated quickly and easily

# PLCnext Technology

Designed by PHOENIX CONTACT

# PLCnext Technology – Future-proof control platform



## Open to variety, succeed through flexibility

In the future, developers from various technological disciplines within a company must work in parallel and yet independently of each other on one automation application.

The group of young high-level language programmers will meet experts from the traditional IEC 61131-3 programming environment. The generation shift within the programming community will be accommodated by the new, open control platform from Phoenix Contact.

PLCnext Technology transfers the communication characteristics e.g. from today's smartphones to industrial automation. The solution enables the parallel development of applications in high-level languages, model-based tools and in IEC 61131-3.

The specialty is that programs that have been created in various development environments can be brought into a PLC-typical, temporal context. This means: high-level language programs will now be deterministic automatically.

The use of readily available software from the open source community is just as much an option as access to cloud-based services and databases. Typical automation tasks will be realized quickly and efficiently through guided engineering.

PLCnext Technology thus offers a unique combination of classic PLC programming and high-level language programming and enables the creation of modern applications within the context of Industrie 4.0.

This new open control platform enables you to be more adaptable and react quickly to new market requirements. Even though development cycles are becoming shorter, you will be able to realize your solutions with increased efficiency and consistent quality.

The AXC F 2152 Axioccontrol controller – the first controller available for this innovative, open platform – is available from November 2017.

## PLCnext Technology

Designed by PHOENIX CONTACT



The AXC F 2152 Axioccontrol controller is the first controller for the new open platform

## Future-proof communication through standardized interfaces – OPC UA

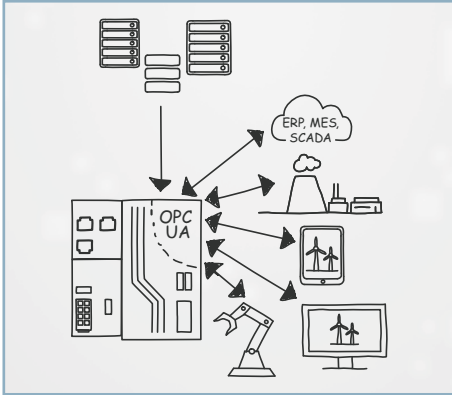

Read process data directly from the controller thanks to the integration of OPC UA

Dynamic market changes make it necessary to solve automation tasks in accordance with Industrie 4.0 approaches. The objective is always to produce more efficiently and intelligently. Uniform protocols, rules, and standards for communication are required to intelligently link machines and system components.

The OPC Unified Architecture Standard, OPC UA, is being adopted more widely as the new market standard and provides the basis for open and standardized communication in the digital future. OPC UA is an integral component of PLCnext Technology, thus making it compatible for integration into third-party systems in the long term.

## Open platform – Linux as a real-time operating system

A Linux real-time operating system forms the basis of the new control platform. You can take advantage of all of the Linux benefits – but very conveniently in the framework of a controlled system. Take advantage of, for example, the expertise and free programs such as an SQL server, software blocks and technologies from the open source community and extend your automation system very efficiently and easily. In this way you save development time and costs – but only when you want to.

In contrast to open Linux PCs, the essential basic functions of a PLC need not be programmed; they are already included. This makes the solution attractive and its use simple. Important PLC functions such as task scheduling, task-consistent data exchange between programs and a data logging module are made available based on the PLCnext Technology as a part of the open control solution.

Benefit from higher efficiency, thanks to these patented functions:

### Execution and Synchronization Manager (ESM):

ESM makes it possible to bring programs from different programming languages into a defined time sequence

### Global Data Space (GDS):

GDS ensures the cycle-consistent process data exchange between programs and fieldbus systems

You can configure all included core functions via the free PC Worx Engineer software. If you would like to continue working in your usual development environment, simple configuration via XML files is available.

Whether you work with Visual Studio, Matlab Simulink, Eclipse or an IEC 61131 programming environment: PLCnext Technology makes possible the fast, controlled startup of your control solution and prevents errors in the basic settings.

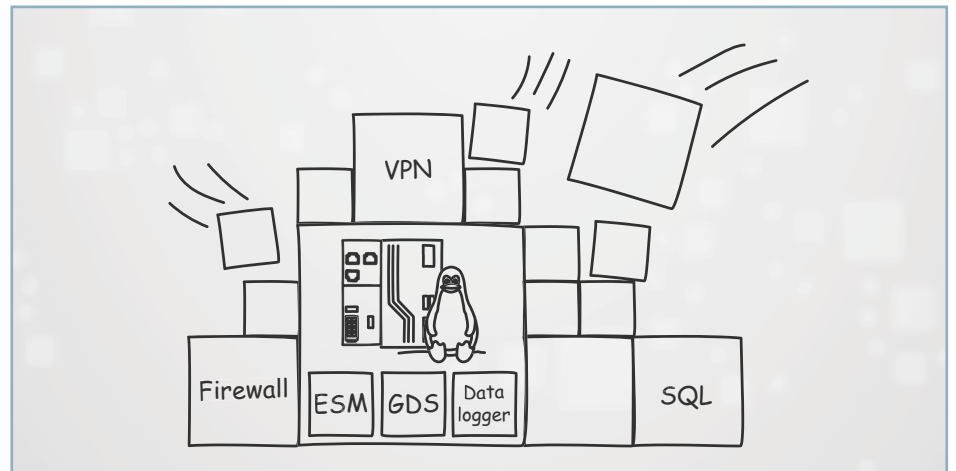

Easily integrate software from the open source community

## Diversity of communication – reliable inclusion of all participants in the field

In addition to OPC UA, the new control platform also understands several other communication protocols. PLCnext Technology also realizes horizontal data exchange between different controllers in addition to vertical communication to the control system or to the Phoenix Contact Proficloud.

Integration into the conventional field level remains possible. Remote control protocols such as IEC 60870-5-104 and 101 are supported for this purpose in addition to PROFINET, CANopen and Modbus.

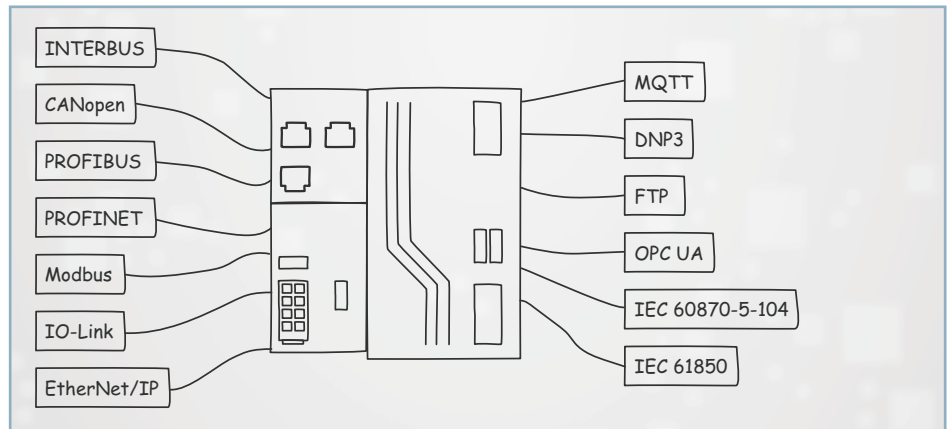

Support of numerous communication protocols and interfaces

## High availability – data logging for predictive maintenance

The aim of predictive maintenance systems is to continuously monitor system statuses, to detect technical changes early on, and to predict the necessity for maintenance in systems and in production areas. Compared to periodical maintenance, the predictive maintenance of systems reduces expensive outages due to system downtimes. A reliable data source is the basis of these predictive models.

Controllers based on PLCnext Technology collect and compile all necessary data from the running process. This information can then be passed on at will and thus, for example, be stored in databases, interpreted by analysis systems or even processed further in the Phoenix Contact Proficloud.

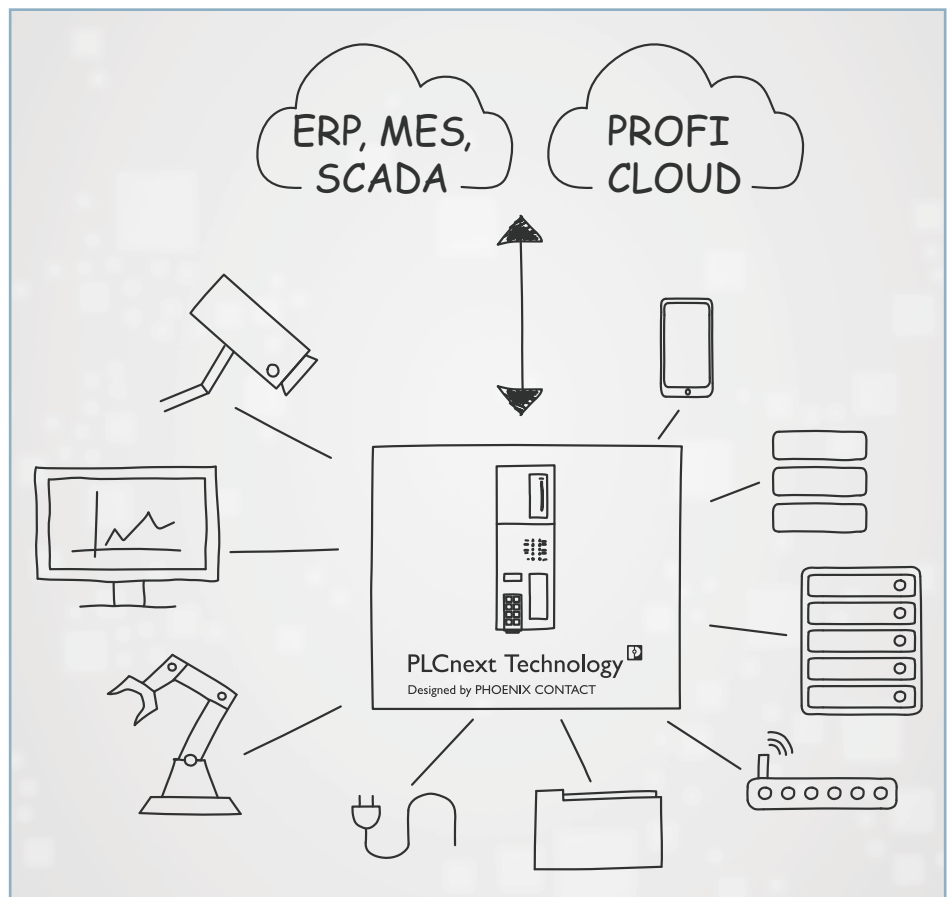

The integrated data logging module records process data in a task-synchronous manner and creates the foundation e.g. of a predictive maintenance system



## Synchronicity and real-time – the controller executes all tasks thanks to patented task handling and real-time data exchange

In addition to executing PLC programs in a single programming language, PLCnext Technology now also offers the option of defining tasks in the controller whose individual components come from different programming languages.

Patented task handling enables any combination of IEC 61131-3 code, high-level languages and model-based tools such as Matlab Simulink in one task. Users not only define the number of PLC tasks; they can also define the precise time sequence as well as the priority.

Adding new functions via an app, from the cloud or through a function block programmed by the user is just as possible as the use of readily available software from the open source community.

Typical automation tasks will be realized quickly and efficiently through controlled engineering. Users can use their own IDE (Integrated Development Environment) or the freely available PC Worx Engineer for this purpose.

Determinism is the fundamental prerequisite for control technology. Until now, this was only possible with defined PLC programming languages. High-level language programs do not have a controlled forced cycle. With the PLCnext Technology, high-level languages will now be automatically deterministic. A patented real-time data exchange (ESM and GDS) between programs of different domains is now ensured with PLCnext Technology.

For you, this means:

Data exchange between programs that have been created in Matlab Simulink, C++, C# or in IEC 61131-3 takes place task-consistently, even if the program sequence is interrupted by a higher priority task. Synchronicity and consistent data access from all programs are thus ensured at all times.

Thanks to multicore support, the processing of tasks can be distributed to multiple processor cores. This makes it possible to optimize utilization of the controller performance.

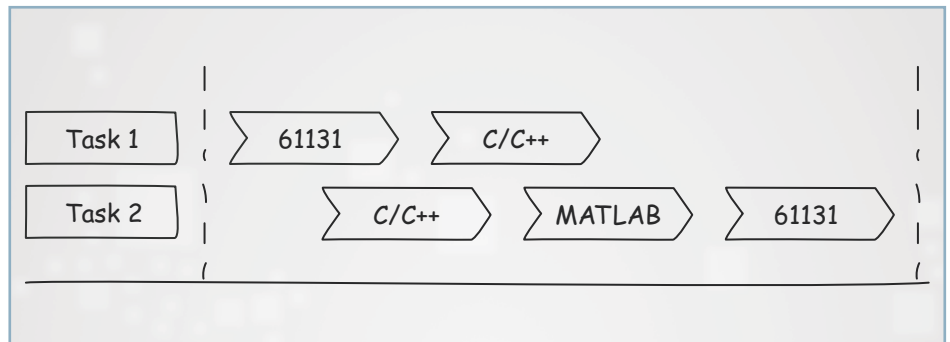

Combine different programming languages in any way in one task

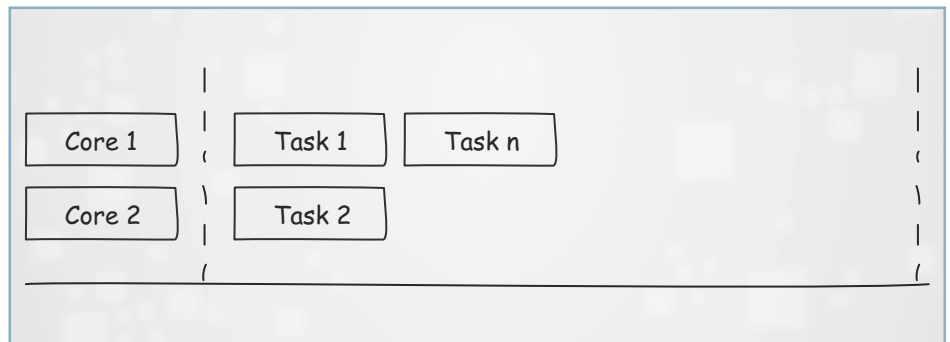

Thanks to multicore support, the processing of tasks can be distributed to multiple processor cores

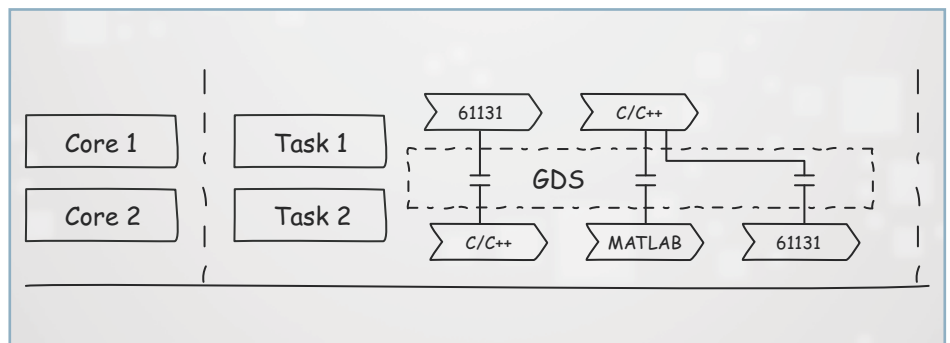

Task-synchronous data exchange between programs of different domains is assured thanks to GDS (Global Data Space)

## Security for your data – fully integrated industrial security

A holistic and deeply integrated security concept is the basis for protecting machines and systems against unauthorized access and risks.

Currently and in the future, even more attention will have to be paid to industry-specific requirements for IT security. Network security and remote maintenance are undoubtedly important in this context, but there is more to an integrated industrial security concept. Today's systems are required to have integrity, be available, and primarily maintain the confidentiality of all data. This is only possible with a deep integration of different mechanisms and procedures on all levels of PLCnext Technology, as well as the PC Worx Engineer development environment. PLCnext Technology therefore offers security by design, so that security aspects can be implemented in accordance with the worldwide leading standard IEC 62443.

Industrial security is therefore no longer an obstacle, but is a key for new project ideas based on the PLCnext Technology.

With PLCnext Technology, Phoenix Contact meets the needs of developers and users in a simple manner. This makes it possible to reduce development times, reduce costs, and the persons involved can focus on the project and their core tasks.

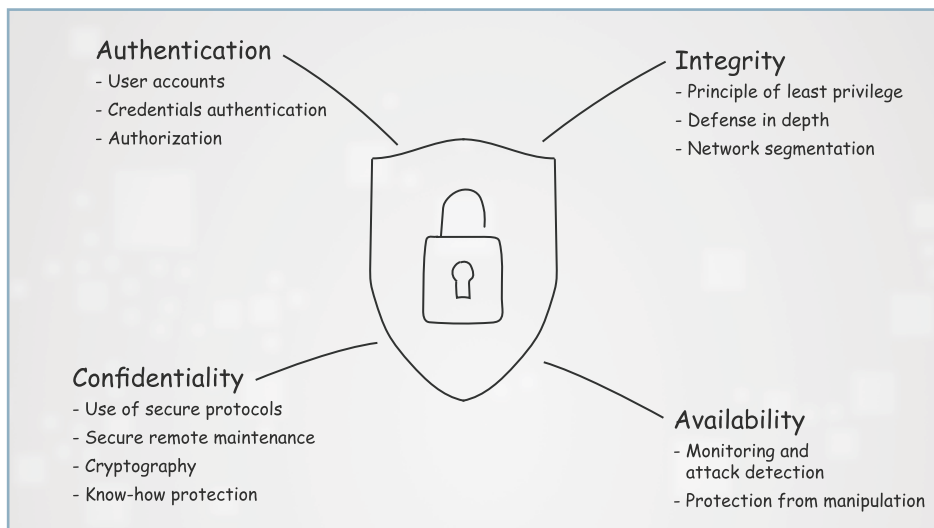

Integrated holistic industrial security concept

## Even more safety for man and machine

In safety technology, components must be easy to handle and safe in operation.

With PC Worx Engineer, it is possible to perform both the standard PLC programming and the programming of all safety functions in one editor. The PLC and safety programming are then installed on the controller in one project. This unpacks itself and automates the programs in two parts – the PLC code and the safety code.

With PLCnext Technology, two additional safe processors are available in the control technology in addition to a multicore processor for the PLC program. These safety processors are from two different manufacturers. The safety program is executed here with redundant diversity to increase failsafe performance. This makes this solution even safer and innovatively protects people and machines.

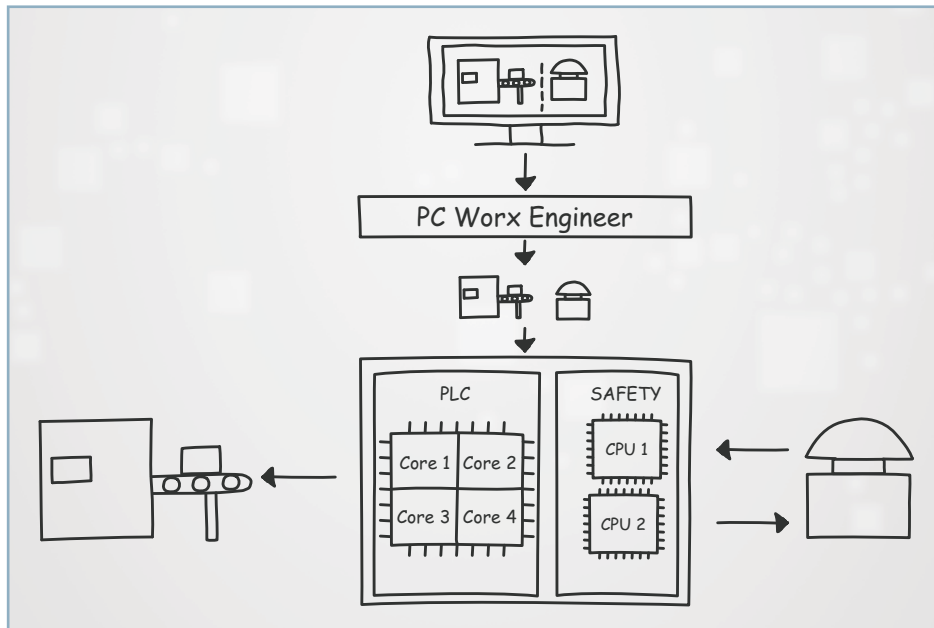

Comprehensive solution for functional safety protects people and machines

## A smooth startup – thanks to comprehensive testing and simulation options

No matter whether short-term changes need to be made to existing automation systems or whether you are planning on creating an entirely new application: the high quality of the solution and the fast and reliable engineering are a prerequisite for being competitive on the market.

Simulation and test scenarios make it possible to check the modified automation solution before live operation and therefore reduce errors and risks.

PLCnext Technology ideally supports each test scenario, no matter whether it is white-box testing, i.e. checking whether the new programming will be operational within the controller, or black-box testing, i.e. a simulated run in the virtual process environment.

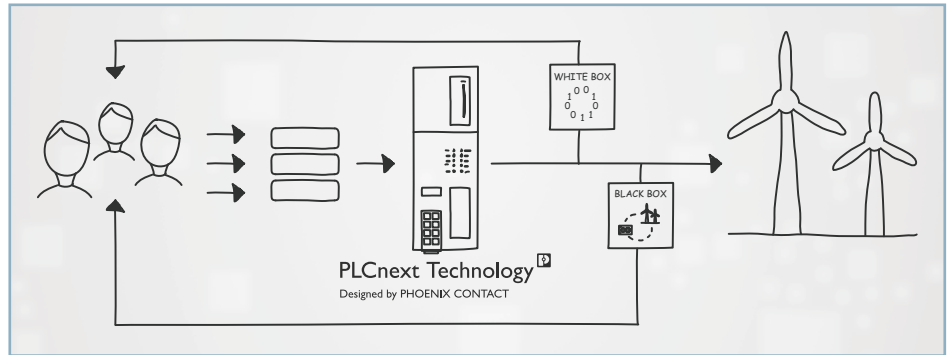

The control platform based on PLCnext Technology supports both white-box and black-box testing

## Fast localization of errors – a comprehensive diagnostics concept

Low downtimes are the prerequisite for efficient production processes. Any malfunction must be quickly and explicitly localized and remedied in order to significantly reduce the costs for technicians and production downtime. PLCnext Technology convinces with an integrated, comprehensive diagnostics concept:

### Cost-effective device diagnostics – Error of an individual component, such as a controller

With PLCnext Technology, our controllers support convenient, web-based management diagnostics – i.e. a web server with preconfigured pages for diagnostics runs on the controllers. This gives you a cost-effective solution because the additional, expensive diagnostics software for connecting to the web server of the controller is not required. You only need an end device with a standard browser of your choosing, such as a PC or a smart device, and network access. All diagnostics data from the device is displayed in the browser.

### Easy system diagnostics – Malfunction in the system, i.e. an error in a production chain

With PLCnext Technology, the diagnostics data of all controllers of the system can be transferred to a central control center. The data transfer is performed via a

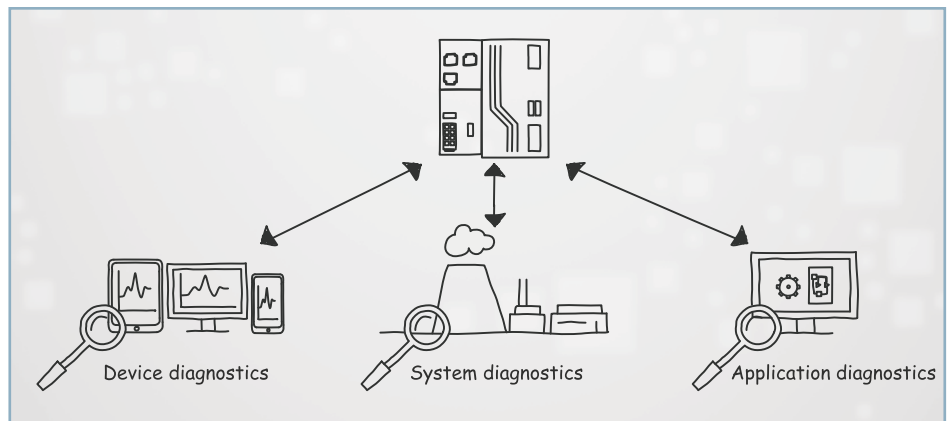

Comprehensive diagnostic functions accelerate the startup process and simplify the identification of causes in the event of a disturbance

standardized OPC UA interface. Thanks to this standardization, all network participants can communicate easily and directly with the control center, without the configuration costs that would normally have been incurred.

### Convenient application diagnostics – Erroneous engineering, i.e. errors in the program code

Both the programming and diagnostics functions are available to you with PLCnext Technology in your preferred and familiar environment. PLCnext Technology also allows you to continue to use your familiar debugging

functions, depending on which tool you as a user feel comfortable with. Whether in Visual Studio, in Eclipse, Matlab Simulink or in PC Worx – remedy errors in your application quickly and effectively.

# PROFICLOUD – Open to the world, succeed securely

With Proficloud, Phoenix Contact offers you consistently professional cloud solutions for automation, tailored to your needs – from cloud devices, to the right platform, right through to cloud services. Professional cloud solutions enable the creation of flexible, optimized processes and the integration of third-party applications such as apps and digital services. Take advantage of the enormous potential and freedom presented by industrial cloud computing and develop future-oriented business ideas for the digital age based on Proficloud.

 Web code: #0949

## Your advantages

- ✓ Maximum availability, because you can access your data anytime, anywhere
- ✓ Openness, because you can develop your own cloud services for Proficloud and operate these in the Proficloud
- ✓ Flexibility, thanks to the possibility of integrating new functions and technologies easily and quickly
- ✓ Future-proof, because the infrastructure, platform, and software are always kept up to date automatically
- ✓ Scalability, thanks to dynamic IT services that can be quickly and individually adjusted to your requirements
- ✓ Secure and certified communication, thanks to TLS encryption

# PROFICLOUD

Professional Cloud Solutions

# PROFICLOUD – Professional cloud solutions



## Open to the world, succeed securely

The trend towards digitization includes opportunities and risks for the industry because digitization requires high computing power and memory capacity. Industrial cloud computing allows companies to process and assess the growing amount of data and then use this to optimize the entire value added chain.

Proficloud provides you with integrated cloud solutions tailored to your needs: from the platform, to connectivity, right through to cloud services. Proficloud enables you to accommodate the new requirements of automation and to establish new digital business models.

Proficloud is designed as an open IoT platform and offers you an entire range of possibilities for recording and assessing the data of your machines and systems worldwide, across company boundaries.

Thanks to PLCnext Technology, you can achieve a seamless transition from the machine level into the cloud. As is to be expected, our Edge controllers perform process-oriented data processing quickly and in real time. The selected and processed data is then securely transferred to the Proficloud.

Proficloud and PLCnext Technology support you in realizing your individual business ideas and enable fast adjustments in the event of business process changes.

Take advantage of use-dependent billing and operate your own software for data acquisition, analysis, and visualization on the cloud platform. You can make selected data and information available to other participants where necessary with secure access. With cloud services, you can extend your applications with services such as monitoring, reporting, energy data management, calculations or preemptive maintenance. To do so, use ready-made services from our range or create your own individual cloud services with our software development kit.

The possibilities are virtually endless.

Those who want to be among the winners of the paradigm shift in automation need to face the challenges of the technical changes and digitize their companies early on.

Make the right decisions today for your future – ensure your business success and join us in the world of Proficloud.

## PROFICLOUD

Professional Cloud Solutions

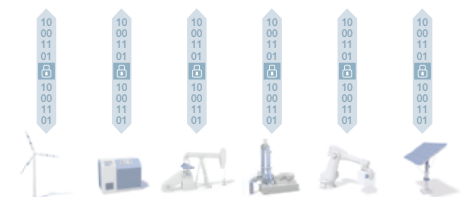
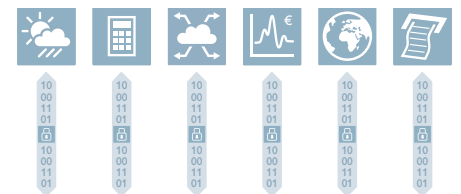

# Digitize your automation solution with PROFICLOUD

## Energy efficiency in building technology

An optimization of the supply processes from building and energy management to the integration of production systems poses new challenges for building operators. Building and supply technology systems need to be linked intelligently to use the large variety of available information intelligently.

Proficloud forms the technical basis for the digitization of building technology and makes

it possible to standardize the data from production, building infrastructure, energy management and superordinate MES/ERP systems. Supply processes in buildings can be optimized with the help of a needs-based assessment via charts or freely defined dashboards.



## Process optimization in the automotive industry

Recording extensive process data is part of the quality certification in the automotive industry. Assessing collected data is gaining in importance on the road to digitization. Energy data such as electric power consumption, temperatures, pressures and flow rates is not only important for assessing and optimizing the process.

This data can be combined with modern analysis procedures and with additional information from production, thanks to the Proficloud. This makes possible manufacturing and process optimization, preemptive maintenance, and ideal lighting of the workstations, depending on the natural light in the factory infrastructure.



## Efficiency gains in solar power

Exact tracking aligns the solar modules with the sun so that sunlight always falls onto the solar panels perpendicularly. This guarantees optimum energy generation. Continually monitoring the system status and the weather data is of great importance in this regard.

Access your systems at any time and from anywhere using the Proficloud. This is the basis for safe, efficient, and reliable monitoring of your tracking parks.



## Data analysis in water and wastewater treatment

Current operating data such as the fill level, flow rate or power consumption of decentralized infrastructures is analyzed in Proficloud and made comparable with other significant parameters. Thus, for example, a water chamber can be operated efficiently and needs-based with the help of weather data

and additional operating data from other structures. In addition, operating data for lifecycle management of multiple shipping locks can be combined to use this efficiently for the preemptive maintenance of the locks.



## In dialog with customers and partners worldwide

Phoenix Contact is a globally present, Germany-based market leader. Our group is synonym for future-oriented components, systems, and solutions in the fields of electrical engineering, electronics, and automation. A global network across more than 100 countries, and 15,000 employees ensure a close proximity to our customers, which we believe is particularly important.

The wide variety of our innovative products makes it easy for our customers to find future-oriented solutions for different applications and industries. We especially focus on the fields of energy, infrastructure, process and factory automation.



You will find our complete product range at:  
[phoenixcontact.com](http://phoenixcontact.com)

PHOENIX CONTACT GmbH & Co. KG  
Flachmarktstraße 8  
32825 Blomberg, Germany  
Phone: +49 52 35 3-00  
Fax: +49 52 35 3-4 12 00  
E-mail: [info@phoenixcontact.com](mailto:info@phoenixcontact.com)  
[phoenixcontact.com](http://phoenixcontact.com)